



USER MANUAL

2(%'ZI %k% @ <\$9P\$J @ <'I <=I @ <I 8KF I ''

EFL&% 8G''

Product may vary. Please refer to the actual product.

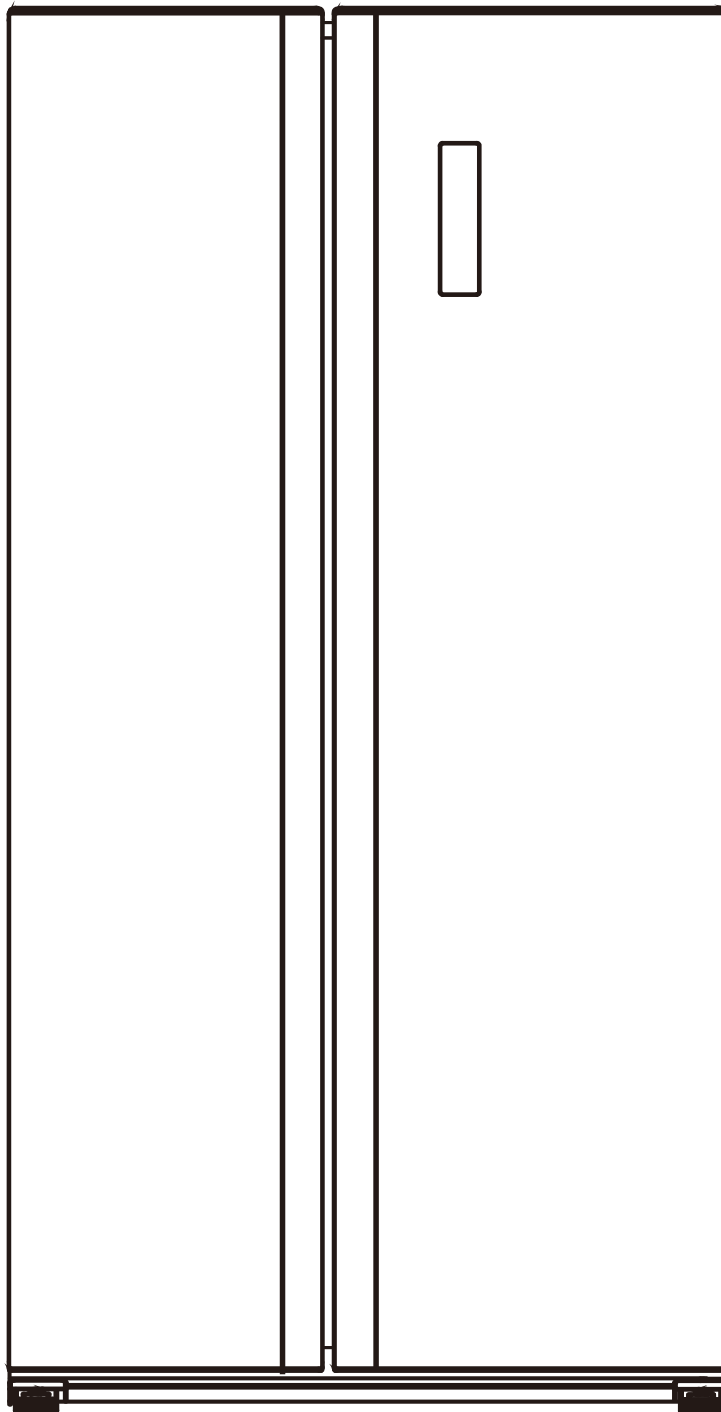

Please read all the instructions carefully before using this product and keep the manual for future reference.



CONTENTS

1. Safety Information	Page 1-5
2. Overview	Page 6
3. Installation	Page 7-9
4. Daily Use	Page 10-14
5. Element Appliance Limited Warranty	Page 15-17





Safety Information

In the interest of your safety and to ensure the correct use, before installing and using the appliance, read this user manual carefully, including its hints and warnings. To avoid unnecessary mistakes and accidents, it is important to ensure that all people using the appliance are thoroughly familiar with its operation and safety features. Save these instructions and make sure that they remain with the appliance if it is moved or sold, so that everyone using it throughout its life will be properly informed on appliance use and safety.

Children and Vulnerable People Safety

- This appliance can be used by children aged 8 years and above and persons with reduced physical, sensory, or mental capabilities or lack of experience and knowledge if they have been given proper supervision or instructions concerning the use of the appliance in a safe way and understand the hazards involved. Children aged 3 to 8 years are allowed to load and unload this appliance.
- Children should be supervised to ensure that they do not play with the appliance.
- Cleaning and user maintenance is not to be done by children unless they are 8 years and above and are being supervised.
- Keep all packaging well away from children. There is a risk of suffocation.
- If you are discarding the appliance pull the plug out of the socket, cut the connection cable (as close to the appliance as you can), and remove the door to prevent children from playing with the appliance and risking electrical shock or suffocation from closing themselves in.
- If this appliance features a magnetic door seal or is replacing an older appliance with a spring lock (latch) on the door or lid, be sure to make sure that the spring latch is unusable before you discard the old appliance. This is to prevent any injury or death of others.

General Safety

-  **WARNING!** Keep ventilation openings in the appliance enclosure or in the built-in structure clear of obstruction.
-  **WARNING!** Do not use mechanical devices or other means to accelerate the defrosting process, other than those recommended by the manufacturer.
-  **WARNING!** Do not damage the refrigerant circuit.
-  **WARNING!** Do not use other electrical appliances (such as ice cream makers) inside refrigerating appliances, unless they are approved for this purpose by the manufacturer.
-  **WARNING!** Do not touch the light bulb if it has been on for a long period of time because it could be very hot.¹⁾

1) If there is a light in the compartment.

Safety Information

 **WARNING!** When positioning the appliance, ensure the supply cord is not trapped or damaged.

 **WARNING!** Do not locate multiple portable socket-outlets or portable power suppliers at the rear of the appliance.

- Do not store explosive substances such as aerosol cans with a flammable propellant in this appliance.
- The refrigerant isobutane (R-600a) is contained within the refrigerant circuit of the appliance, a natural gas with a high level of environmental compatibility, which is nevertheless flammable.
- During transportation and installation of the appliance, be certain that none of the components of the refrigerant circuit become damaged.
- avoid open flames and sources of ignition
- thoroughly ventilate the room in which the appliance is situated
- It is dangerous to alter the specifications or modify this product in any way. Any damage to the cord may cause a short circuit, fire, and/or electric shock.
- This appliance is intended to be used in household and similar applications such as:

- staff kitchen areas in shops, offices, and other working environments
- farmhouses and by clients in hotels, motels, and other residential type environments

- bed and breakfast type environments
- catering and similar non-retail applications

 **WARNING!** Any electrical components (plug, power cord, compressor, etc.) must be replaced by a certified service agent or qualified service personnel.

 **WARNING!** The light bulb supplied with this appliance is a "special use light bulb" usable only with the appliance supplied. This special use light is not usable for domestic lighting.¹⁾

- Power cord must not be lengthened.
- Make sure that the power plug is not crushed or damaged by the back of the appliance. A crushed or damaged power plug may overheat and cause a fire.
- Make sure that you can access the main plug of the appliance.
- Do not pull the main cable.
- If the power plug socket is loose, do not insert the power plug. There is a risk of electric shock or fire.
- You must not operate the appliance without the light.
- This appliance is heavy. Care should be taken when moving it.
- Do not remove or touch items from the freezer compartment if your hands are damp/wet, as this could cause skin abrasions or frost/freezer burns.
- Avoid prolonged exposure of the appliance to direct sunlight.

1) If there is a light in the compartment.

Safety Information

Daily use

- Do not put hot items on the plastic parts inside the appliance.
- Do not place food products directly against the rear wall.
- Frozen food must not be refrozen once it has been thawed out.¹⁾
- Store pre-packed frozen food in accordance with the frozen food manufacturer's instructions.¹⁾
- Appliance manufacturer's storage recommendations should be strictly adhered to. Refer to relevant instructions.
- Do not place carbonated or fizzy drinks in the freezer compartment as it creates pressure in the container, which may cause it to explode, resulting in damage to the appliance.¹⁾
- Popsicles can cause frost bites if consumed straight from the appliance.¹⁾
- To avoid contamination of food, please respect the following instructions:
 - Opening the door for long periods can cause a significant increase in temperature in the compartments of the appliance.
 - Regularly clean surfaces that come in contact with food and accessible drainage systems.
 - Clean water tanks if they have not been used for 48 hours; flush the water system connected to a water supply if the water has not been used in 5 days.
 - Store raw meat and fish in suitable containers in the refrigerator, so that they are not in contact with or drip onto other food.

Care and Cleaning

- Before maintenance, switch the appliance off and disconnect the main plug from the main socket.
- Do not clean the appliance with metal objects.
- Do not use sharp objects to remove frost from the appliance. Use a plastic scraper.¹⁾
- Examine the drain regularly in the refrigerator for defrosted water. If necessary, clean the drain.
- If the drain is blocked, water will collect in the bottom of the appliance.²⁾

1) If there is a freezer compartment.

2) If there is a fresh-food storage compartment.

Safety Information

Installation

Important! For electrical connection, carefully follow the instructions given in specific paragraphs.

- Unpack the appliance and check if there are damages on it. Do not connect the appliance if it is damaged. Report possible damages immediately to the place you bought it. In that case, keep the packaging.
- It is advisable to wait at least four hours before connecting the appliance to allow the oil to flow back in the compressor.
- Adequate air circulation should be around the appliance, lacking this leads to overheating. To achieve sufficient ventilation follow the instructions relevant to installation.
- Wherever possible the spacers of the product should be against a wall to avoid touching or catching warm parts (compressor, condenser) to prevent possible burn.
- The appliance must not be located close to radiators or cookers.
- Make sure that the main plug is accessible after the installation of the appliance.

Service

- If any electrical work is required, the appliance should be serviced by a qualified electrician or service personnel.
- This product must be serviced by an authorized Service Center, and only genuine spare parts must be used.

Energy Saving

- Don't put hot food in the appliance;
- Don't pack food close together as this prevents air circulating;
- Make sure food does not touch the back of the compartment(s);
- If electricity goes out, don't open the door(s)
- Don't open the door(s) frequently
- Don't keep the door(s) open for too long time
- Don't set the thermostat on exceeding cold temperatures
- All accessories, such as drawers, shelves, balconies, should be kept there for lower energy consumption.



PROP. 65 WARNING FOR CALIFORNIA RESIDENTS



WARNING:

Cancer And Reproductive Harm

www.p65warnings.ca.gov

Safety Information

Environment Protection

 This appliance does not contain gases which could damage the ozone layer, in either its refrigerant circuit or insulation materials. The appliance shall not be discarded together with the urban refuse and rubbish. The insulation foam contains flammable gases: the appliance shall be disposed according to the appliance regulations obtained from your local authorities. Avoid damaging the cooling unit, especially the heat exchanger. The materials used on this appliance marked by the symbol  are recyclable.



The symbol on the product or on its packaging indicates that this product may not be treated as household waste. Instead, it should be taken to the appropriate collection point for the recycling of electrical and electronic equipment. By ensuring this product is disposed of correctly you will help prevent potential negative consequences for the environment and human health, which could otherwise be caused by inappropriate waste handling of this product. For more detailed information about recycling of this product, please contact your local council, your household waste disposal service or the shop where you purchased the product.

Packaging Materials

- The materials with the symbol are recyclable.
- Dispose the packaging in a suitable garbage cans to recycle it.

Disposal of the Appliance

1. Disconnect the main plug from the main socket.
2. Cut off the main cable and discard it.



 **WARNING!** During using, service and disposal the appliance, please pay attention to symbols similar as left side, which is located on rear of appliance (rear panel or compressor) and with yellow or orange color.

It's risk of fire warning symbol. There are flammable materials in refrigerant pipes and compressor.

Please be far away fire source during using service and disposal.



Caution: risk of fire



IT IS HAZARDOUS FOR ANYONE OTHER THAN AUTHORIZED SERVICE PERSONNEL TO CARRY OUT SERVICES OR REPAIRS INVOLVING THE REMOVAL OF COVERS.



TO AVOID THE RISK OF AN ELECTRICAL SHOCK DO NOT ATTEMPT REPAIRS YOURSELF.

Overview

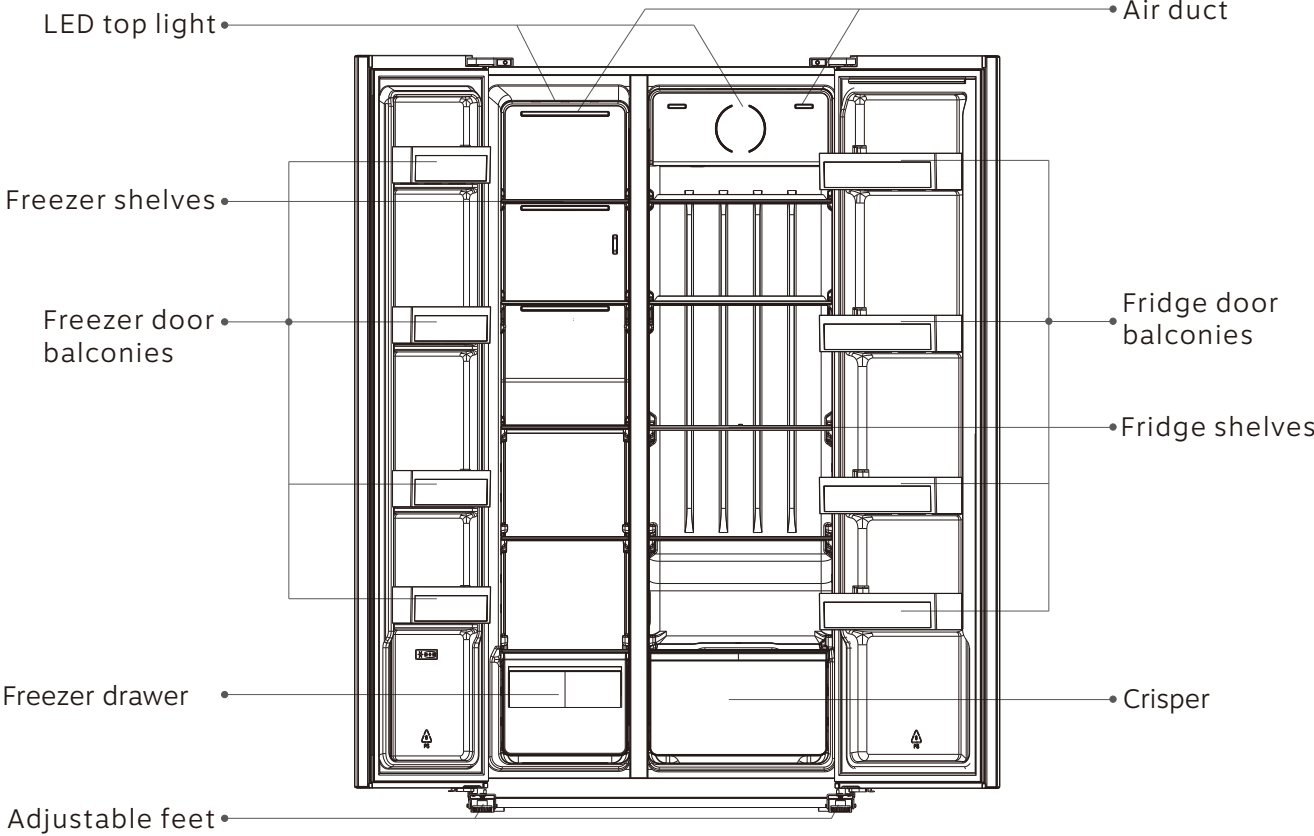

The illustration is only for hinting, for details please check your appliance.

Installation

Remove the Doors

Tools required: Philips screwdriver, Flat bladed screwdriver.

- Ensure the unit is unplugged and empty.
- To take the door off, it is necessary to tilt the unit backwards. You should rest the unit on something solid so that it will not slip during the door removing process.
- All parts removed must be saved to do the reinstallation of the door.
- Do not lay the unit flat as this may damage the coolant system.
- It's better that 2 people handle the unit during assembly.

1. Unscrew hinge cover by Philips screwdriver.

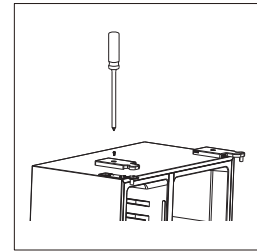

2. Disconnect the harness

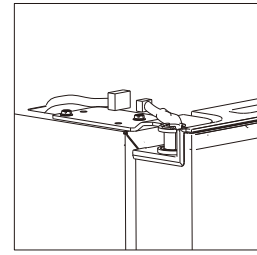

3. Unscrew top hinge

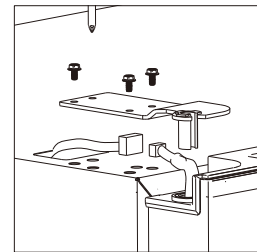

4. Lift the door and place it on a soft pad. Then remove another door as same process.

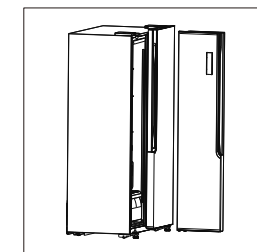

5. Unscrew bottom hinges.

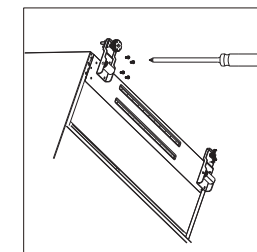

6. After the appliance is positioned, install the doors as reversed process.

Installation

Space Requirement

- Keep enough space so the door can open.
- Keep at least 50mm of space between the two sides and the back.

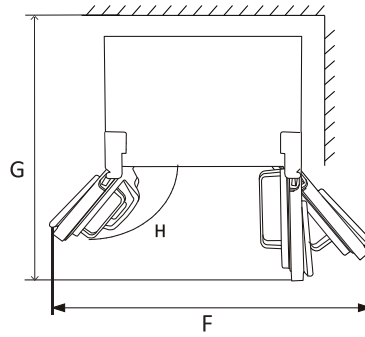
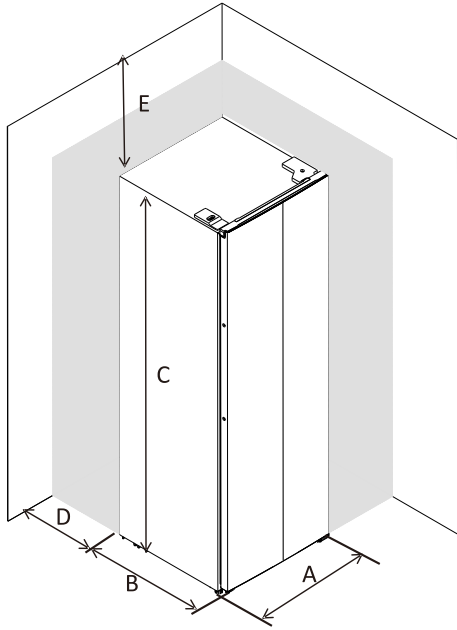

A	35.8 inch
B	28.7 inch
C	69.7 inch
D	2 inch
E	2 inch
F	61.6 inch
G	48.0 inch
H	140°

Leveling the Refrigerator

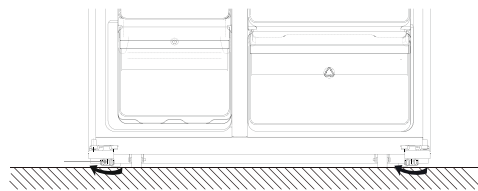
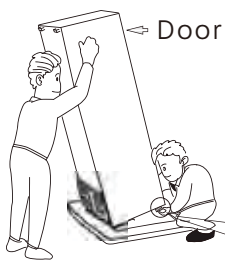

- Rotate the feet clockwise to heighten them by hand.
- Rotate the feet counterclockwise to lower them by hand.



Installation

Positioning

Install this appliance at a location where the ambient temperature corresponds to the climate class indicated on the rating plate of the appliance.

For refrigerating appliances with climate class:

- Extended temperate: this refrigerating appliance is intended to be used at ambient temperatures ranging from 50°F to 90°F; (SN)
- Temperate: this refrigerating appliance is intended to be used at ambient temperatures ranging from 61°F to 90°F; (N)
- Subtropical: this refrigerating appliance is intended to be used at ambient temperatures ranging from 61°F to 100°F; (ST)
- Tropical: this refrigerating appliance is intended to be used at ambient temperatures ranging from 61°F to 109°F; (T)

Location

The appliance should be installed well away from sources of heat such as radiators, boilers, direct sunlight, etc. Ensure that air can circulate freely around the back of the cabinet. To ensure the best performance, if the appliance is positioned below an overhanging wall unit, the minimum distance between the top of the cabinet and the wall unit must be at least 4 inches. Ideally, however, the appliance should not be positioned below overhanging wall units. Accurate leveling is ensured by one or more adjustable feet at the base of the cabinet.

This refrigerating appliance is not intended to be used as a built-in appliance.

 **Warning!** It must be possible to disconnect the appliance from the main power supply; the plug must therefore be easily accessible after installation.

Electrical Connection

Before plugging in, ensure that the voltage and frequency shown on the rating plate correspond to your domestic power supply. The appliance must be earthed. The power supply cable plug is provided with a contact for this purpose.



Daily Use

Using the Control Panel

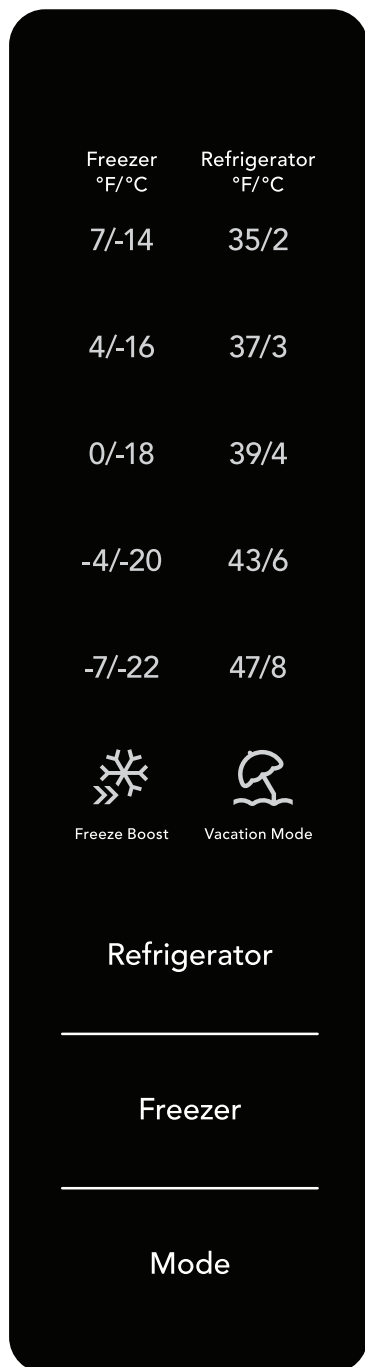

Freezer Temp

Displays the set temperature of the freezer compartment.

Refrigerator Temp

Displays the set temperature of the refrigerator compartment.

Freeze Boost

Activates a faster rate for freezing food in the freezer compartment. Use this feature when loading several items into the freezer at one time. Automatically deactivates after 50 hours.

Vacation Mode

Vacation mode is designed to save energy when the unit is not being actively used and contains very few food items.

Refrigerator

Press to adjust temperature of refrigerator compartment (right side).

Freezer

Press to adjust temperature of freezer compartment (left side).

Modes

Press to select running mode.

Daily Use

First Use

Cleaning the interior

Before using the appliance for the first time, wash the interior and all internal accessories with lukewarm water and some neutral soap so as to remove the typical smell of a brand new product, then dry thoroughly.

Important! Do not use detergents or abrasive powders, as these will damage the finish.

Daily Use

Position different food in different compartments according to the below table.

Refrigerator Compartments	Type of Food
Door or balconies of fridge compartment	<ul style="list-style-type: none">Foods with natural preservatives, such as jams, juices, drinks, condiments.Do not store perishable foods.
Crisper zone	<ul style="list-style-type: none">Fruits, herbs, and vegetables should be placed separately in the crisper bin.Do not store bananas, onions, potatoes, garlic in the refrigerator.
Fridge shelf	<ul style="list-style-type: none">Dairy, eggs, cakes, pasta, pizza.Foods that do not need cooking, such as ready-to-eat foods, deli meats, leftovers.
Freezer compartment	<ul style="list-style-type: none">Foods for long-term storage.Seafood, fish, meat, dumplings, frozen baked goods.

Thawing

Deep-frozen or frozen food, prior to be used, can be thawed in the freezer compartment or at room temperature, depending on the time available for this operation. Small pieces may even be cooked still frozen, directly from the freezer. In this case, cooking will take longer.

Accessories

Movable shelves

The walls of the refrigerator are equipped with a series of runners so that the shelves can be positioned as desired.

Positioning the door balconies

To permit storage of food packages of various sizes, the door balconies can be placed at different heights. To make these adjustments proceed as follows: gradually pull the balcony in the direction of the arrows until it comes free, then reposition as required.

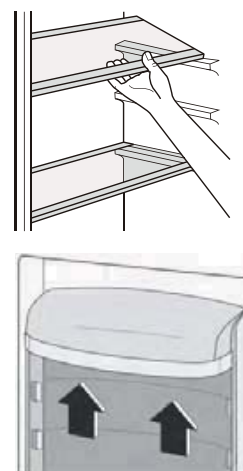

Daily Use

Helpful Hints and Tips

Hints for freezing

To help you make the most of the freezing process, here are some important hints:

- The maximum quantity of food which can be frozen in 24 hrs. is shown on the rating plate
- The freezing process takes 24 hours. No further food to be frozen should be added during this period
- Only freeze top quality, fresh and thoroughly cleaned food
- Prepare food in small portions to enable it to be rapidly and completely frozen and to make it possible to thaw only the quantity required
- Wrap up the food in aluminum foil or polythene and make sure that the packages are airtight
- Do not allow fresh, unfrozen food to touch food which is already frozen, thus avoiding a rise in temperature of the latter
- Lean foods store better and longer than fatty ones; salt reduces the storage life of food
- Water ices, if consumed immediately after removal from the freezer compartment, can possibly cause the skin to be freeze burnt
- It is advisable to show the freezing date on each individual pack to enable the removal from the freezer compartment, can possibly cause the skin to be freezer burnt
- It is advisable to show the freezing date on each individual pack to enable you to keep tab of the storage time

Hints for storage of frozen food

To obtain the best performance from this appliance, you should:

- Make sure that the commercially frozen food were adequately stored by the retailer
- Be sure that frozen food are transferred to the freezer in the shortest possible time
- Do not open the door frequently or leave it open longer than absolutely necessary
- Once defrosted, food deteriorates rapidly and cannot be refrozen
- Do not exceed the storage period indicated by the food manufacturer

Hints for fresh food refrigeration

To obtain the best performance:

- Do not store warm food or evaporating liquids in the refrigerator
- Do cover or wrap the food, particularly if it has a strong flavor

Hints for refrigeration

Useful hints:

- Meat (all types): wrap in polythene bags and place on the glass shelves above the vegetable drawer. For safety, store in this way only one or two days at the most.
- Cooked foods, cold dishes, etc.: these should be covered and may be placed on any shelf.
- Fruit and vegetables: these should be thoroughly cleaned and placed in the special drawer(s) provided.
- Butter and cheese: these should be placed in special airtight containers or wrapped in aluminum foil or polythene bags to exclude as much air as possible.
- Milk: these should have a cap and should be stored in the balconies on the door.
- Bananas, potatoes, onions and garlic, if not packed, must not be kept in the fridge.

Daily Use

Cleaning

For hygienic reasons, the appliance interior, including interior accessories, should be cleaned regularly.

 **Caution!** The appliance may not be connected to the outlet during cleaning. Danger of electrical shock! Before cleaning, switch the appliance off and remove the plug from the outlet, or switch off or turn out the circuit breaker or fuse. Never clean the appliance with a steam cleaner. Moisture could accumulate in electrical components, danger of electrical shock! Hot vapors can lead to the damage of plastic parts. The appliance must be dry before it is placed back into service.

Important! Ethereal oils and organic solvents can attack plastic parts, e.g., lemon juice or the juice from orange peel, butyric acid, cleansers that contain acetic acid.

- Do not allow such substances to come into contact with the appliance parts.
- Do not use any abrasive cleaners.
- Remove the food from the freezer. Store them in a cool place, well covered.
- Switch the appliance off and remove the plug from the mains, or switch off or turn out the circuit breaker or fuse.
- Clean the appliance and the interior accessories with a cloth and lukewarm water. After cleaning, wipe with fresh water and rub dry.
- After everything is dry, place the appliance back into service.

Daily Use

Troubleshooting



Caution! Before troubleshooting, disconnect the power supply. Only a qualified electrician or competent person must do the troubleshooting that is not in this manual.

Important! There are some sounds during normal use (compressor, refrigerant circulation).

Problem	Possible cause	Solution
Appliance does not work	The main plug is not plugged in or is loose.	Insert the main plug.
	Fuse has blown or is defective.	Check fuse, replace if necessary.
	Socket is defective.	outlet malfunctions are to be corrected by an electrician.
Appliance freezes or cools too much	Temperature is set too cold or the appliance runs at SUPER modes.	Turn the temperature regulator to a warmer setting temporarily. Please look in the initial Temperature Setting section.
The food is not frozen enough	Temperature is not properly adjusted.	Open the door only as long as necessary.
	Door was open for an extended period.	Turn the temperature regulation to a colder setting temporarily. Please look in the installation location section.
	A large quantity of warm food was placed in the appliance within the last 24 hours.	Turn the temperature regulation to a colder setting temporarily.
	The appliance is near a heat source.	Please look in the installation location section.
Heavy build up of frost on the door seal	Door seal is not airtight.	Carefully warm the leaking sections of the door seal with a hair dryer (on a cool setting). At the same time, shape the warmed door seal by hand such that it sits correctly.
Unusual noises	Appliance is not level.	Re-adjust the feet.
	The appliance is touching the wall or other objects.	Move the appliance slightly.
	A component, e.g., a pipe, on the rear of the appliance is touching another part of the appliance or the wall.	If necessary, carefully bend the component out of the way.
Side panels are hot	It's normal. Heat exchange is in the side panels.	Take gloves to touch side panels if needed.

If the malfunction shows again, contact the Service Center. These data are necessary to help you quickly and correctly. Write the necessary data here, refer to the rating plate.

Element Appliance Limited Warranty

(the “Products” or “Product” when referencing a singular product herein)

This Product (including any accessories included in the original packaging) as supplied and distributed in new condition, is warranted by Element Appliance Company, LLC (“Element”) to the original customer who purchases the Product from an authorized Element retailer (the “Original Customer” or “you”) against defects in material and workmanship under proper use, maintenance, and care according to the owner’s manual, warnings, and instructions accompanying the Product (“Warranty”) as follows:

* **PLEASE NOTE** – Proof of purchase evidencing the date of purchase by the Original Purchaser from an authorized Element retailer (“Valid Proof of Purchase”) is **required** for all Warranty service. The express Warranty set forth herein is subject to all terms and conditions set forth below.

1. **WARRANTY SERVICE:**

A. ONE-YEAR WARRANTY: Except as provided in subpart 1.B below, for a period of **one (1) year** from the date of purchase by the Original Customer (the “Warranty Period”), if the parts or components covered by this Warranty are determined by Element or Element’s authorized service provider to be defective in material or workmanship, Element will, at its sole and absolute discretion and option: (i) repair the defective part or component at no charge to the Original Customer, (ii) replace the defective Product with a new Product of similar or better quality, at no charge to the Original Customer, or (iii) refund the documented purchase price paid by the Original Customer (excluding tax) to the Original Customer upon return of the defective Product as directed by Element. After the Warranty Period expires, the Original Customer must pay for all parts, components, shipping and handling, labor, and replacement costs associated with the Product or any part or component thereof, regardless of any defects in the Product or any part or component thereof.

B. LIMITED EXTENDED WARRANTY THROUGH PRODUCT REGISTRATION: If and only if the Original Customer registers the Product at www.elementelectronics.com within **ninety (90)** days of the date of purchase by the Original Customer, then the Warranty Period discussed in subpart 1.A. above shall be extended an additional one (1) year to a new Warranty Period equaling **two (2) years** from the date of purchase by the Original Customer. If the Product is not registered as provided for in this subpart 1.B, then the standard one-year Warranty Period set forth in subpart 1.A shall apply.

C. TIMING AND PROCEDURE: Before Warranty service can commence, the Original Customer must contact either (i) the retailer from whom the Original Customer purchased the Product, or (ii) Element directly, in either case for problem determination and service procedures. Valid Proof of Purchase evidencing that the Product is within the Warranty Period **MUST** be presented by Original Customer in order to obtain the requested Warranty service. Please have your model and serial number available, along with your date of purchase of the Product. To remain eligible for Warranty service, Original Customer may not return the Product or any part or component thereof to the retailer or Element without Element’s prior written consent.

2. EXCLUSIONS AND LIMITATIONS TO WARRANTY SERVICE

The Warranty covers manufacturing defects in materials and workmanship of the Product encountered in the normal, non-commercial use of the Product, and **does not cover** (a) damages or malfunctions resulting from improper or unreasonable use or maintenance, abuse, negligence, failure to follow instructions contained in any written materials that accompany the Product, deterioration by reason of excess moisture, corrosive atmosphere, lightning, power surges, connections to improper voltage supply, unauthorized alteration, or other external causes such as extremes in temperature or humidity, modifications, scratches or discoloration; (b) any damage caused by using non-authorized parts or service facilities for repair of Products (however, for avoidance of doubt, using non-authorized parts or service facilities will not, in and of itself, void the Warranty); (c) transportation, shipping, delivery, pickup, insurance, installation, or set-up costs; (d) ordinary wear and tear, cosmetic damage, or damage due to acts of nature, including but not limited to, water, floods, wind, storm, tornado, earthquake, or fire, or due to damage caused by extraordinary impact events, such as dropping, crushing, demolition or other extraordinary damage; (e) commercial use of the Product, or use of the Product for anything other than single-family household or residential use; or (f) modification of the Product or any part of the Product.

This Warranty is made to the Original Customer only and does not cover Products sold AS IS or WITH ALL FAULTS. The Warranty is invalid if the factory-applied serial number has been altered or removed from the Product. This Warranty is valid only in the United States, and only applies to Product if it was purchased and serviced in the United States. The addition of equipment or features to the Product that are not manufactured or recommended by Element could affect the intended function of the Product, and therefore may void the Warranty. Furthermore, the exposure of the Product to chemicals, heat, cold, humidity, or other elements can affect the Product components, and therefore, the Warranty does not cover discoloration, fading, cosmetic changes, rust, or any damages or failure related to any such items. The Warranty is contingent upon the proper use, maintenance, and care of the Product. The Warranty may be void if the Product has been used in a manner contradictory to, or in violation of, the terms of the user's manual, warnings, or instructions accompanying the Product.

THIS WARRANTY IS MADE IN LIEU OF AND SUPERSEDES ALL OTHER WARRANTIES OR CONDITIONS OF MERCHANTABILITY OR FITNESS FOR A PARTICULAR PURPOSE OR GENERAL USE, WHETHER EXPRESS, IMPLIED, COLLATERAL, STATUTORY, OR PROVIDED BY COMMON LAW, THE UNIFORM COMMERCIAL CODE, OR OTHERWISE. ELEMENT FURTHER DISCLAIMS ALL WARRANTIES AFTER THE END OF THE WARRANTY TERM DEFINED ABOVE. NO OTHER EXPRESS WARRANTY OR GUARANTY GIVEN BY ANY OTHER PERSON, FIRM, OR ENTITY WITH RESPECT TO THE PRODUCT SHALL BE BINDING ON ELEMENT. REPAIR, REPLACEMENT, OR REFUND OF THE ORIGINAL PURCHASE PRICE, AT ELEMENT'S SOLE DISCRETION, ARE THE EXCLUSIVE REMEDIES OF THE CUSTOMER.

ELEMENT SHALL NOT BE LIABLE FOR ANY INCIDENTAL OR CONSEQUENTIAL DAMAGES CAUSED BY THE USE, MISUSE, OR INABILITY TO USE THE PRODUCT. THESE INCLUDE, BUT ARE NOT LIMITED TO, ANY DAMAGES IN THE FORM OF LOST PROFITS, LOSS OF USE, LEGAL FEES, ECONOMIC LOSS, PERSONAL INJURIES, OR ANY OTHER DAMAGES CAUSED BY CIRCUMSTANCES BEYOND THE CONTROL OF ELEMENT. NOTWITHSTANDING THE FOREGOING, ELEMENT'S AGGREGATE LIABILITY TO ANY CUSTOMER SHALL NOT EXCEED THE ORIGINAL PURCHASE PRICE OF THE PRODUCT. THIS WARRANTY SHALL NOT EXTEND TO ANYONE OTHER THAN THE ORIGINAL CUSTOMER WHO PURCHASED THE



PRODUCT, AND IS NOT TRANSFERRABLE. NO PERSON IS AUTHORIZED TO ALTER, EXTEND, OR WAIVE THIS WARRANTY OR ANY OF ITS TERMS OR CONDITIONS.

Some states do not allow the exclusion or limitation of incidental or consequential damages, or allow limitations on warranties, so the above limitations or exclusions may not apply to you. This Warranty gives you specific rights, and you may have other rights, which vary from state to state. The exclusions and limitations to the Warranty apply to the maximum extent permitted by law and unless restricted or prohibited by law. Where any term of this Warranty is prohibited by applicable law, it shall be null and void, but the remainder of this Warranty shall remain in effect.

PLEASE DIRECT ALL CORRESPONDENCE TO:

Element Appliance Company, LLC
customerservice@elementelectronics.com
(888) 842-3577
<https://elementelectronics.com>





Element, the Element Logo, and Bring it home are trademarks of Element Brand Holding, LLC. All other trademarks are the property of their respective owner, who has not sponsored, endorsed, or approved this product. ©2024 Element Appliance Company, LLC. All rights reserved.

Distributed by Element Appliance Company, LLC
Augusta, GA 30909

For service, support and warranty information:
Call 888.842.3577, email us at
customerservice@elementelectronics.com
or visit www.elementelectronics.com